

ICE30N60W N-Channel Enhancement Mode MOSFET

| Product Summary | | | |
|-----------------|------------------------|---------------|-----|
| I_D | $T_C=25^\circ\text{C}$ | 30A | Max |
| $V_{(BR)DSS}$ | $I_D=1\text{mA}$ | 600V | Min |
| $r_{DS(on)}$ | $V_{GS}=10\text{V}$ | 0.06 Ω | Typ |
| Q_g | $V_{DS}=480\text{V}$ | 189nC | Typ |

Features

- TO247 package
- Low $r_{DS(on)}$
- Ultra Low Gate Charge
- High dv/dt capability
- High Unclamped Inductive Switching (UIS) capability
- High peak current capability
- Increased transconductance performance
- Optimized design for high performance power systems



Lead Free

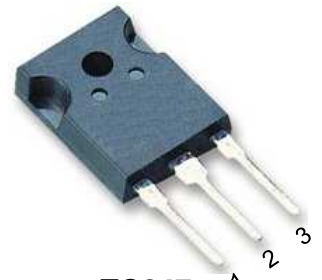
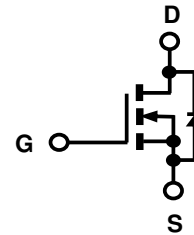

TO247
1:G, 2:D,
3:S, 4:D,
(TO-247)

ICEMOS AND ITS SISTER COMPANY 3D SEMI OWN THE FUNDAMENTAL PATENTS FOR SUPERJUNCTION MOSFETS. THE MAJORITY OF THESE PATENTS HAVE 17 to 20 YEARS OF REMAINING LIFE. THIS PORTFOLIO HAS GRANTED PATENTS ISSUED IN USA, CHINA, KOREA, JAPAN, TAIWAN & EUROPE.

Maximum ratings at $T_j=25^\circ\text{C}$, unless otherwise specified

| Parameter | Symbol | Conditions | Value | Unit |
|-----------------------------------|----------------|--|-------------|------------------|
| Continuous drain current | I_D | $T_C=25^\circ\text{C}$ | 30 | A |
| | | $T_C=100^\circ\text{C}$ | 19 | |
| Pulsed drain current | $I_{D, pulse}$ | $T_C=25^\circ\text{C}$ | 117 | A |
| Avalanche energy, single pulse | E_{AS} | $I_D=15\text{A}$ | 1100 | mJ |
| Avalanche current, repetitive | I_{AR} | limited by $T_j\text{max}$ | 15 | A |
| MOSFET dv/dt ruggedness | dv/dt | $V_{DS}=480\text{V}$, $I_D=30\text{A}$, $T_j=125^\circ\text{C}$ | 50 | V/ns |
| Gate source voltage | V_{GS} | Static | ± 20 | V |
| | | AC ($f>1\text{Hz}$) | ± 30 | |
| Power dissipation | P_{tot} | $T_C=25^\circ\text{C}$ | 171 | W |
| Operating and storage temperature | T_j, T_{stg} | | -55 to +150 | $^\circ\text{C}$ |
| Mounting torque | | M 3 & 3.5 screws | 60 | Ncm |

a When mounted on 1inch square 2oz copper clad FR-4

| Parameter | Symbol | Conditions | Values | | | Unit |
|-----------|--------|------------|--------|-----|-----|------|
| | | | Min | Typ | Max | |

Thermal characteristics

| | | | | | | |
|---|------------|-------------------------------------|---|---|------|------|
| Thermal resistance, junction-case ^a | R_{thJC} | | - | - | 0.73 | °C/W |
| Thermal resistance, junction-ambient ^a | R_{thJA} | leaded | - | - | 62 | |
| Soldering temperature, wave soldering only allowed at leads | T_{sold} | 1.6mm (0.063in.) from case for 10 s | - | - | 260 | °C |

Electrical characteristics at $T_j=25^\circ\text{C}$, unless otherwise specified

Static characteristics

| | | | | | | |
|----------------------------------|---------------|---|-----|------|-------|---------------|
| Drain-source breakdown voltage | $V_{(BR)DSS}$ | $V_{GS}=0\text{ V}, I_D=1\text{ mA}$ | 600 | 640 | - | V |
| Gate threshold voltage | $V_{GS(th)}$ | $V_{DS}=V_{GS}, I_D=250\mu\text{A}$ | 2.1 | 3.2 | 3.9 | |
| Zero gate voltage drain current | I_{DSS} | $V_{DS}=600\text{ V}, V_{GS}=0\text{ V}, T_j=25^\circ\text{C}$ | - | 0.5 | 1 | μA |
| | | $V_{DS}=600\text{ V}, V_{GS}=0\text{ V}, T_j=150^\circ\text{C}$ | - | 80 | - | |
| Gate source leakage current | I_{GSS} | $V_{GS}=\pm 20\text{ V}, V_{DS}=0\text{ V}$ | - | - | 200 | nA |
| Drain-source on-state resistance | $r_{DS(on)}$ | $V_{GS}=10\text{ V}, I_D=15\text{ A}, T_j=25^\circ\text{C}$ | - | 0.06 | 0.068 | Ω |
| | | $V_{GS}=10\text{ V}, I_D=15\text{ A}, T_j=150^\circ\text{C}$ | - | 0.16 | - | |
| Gate resistance | R_G | $f=1\text{ MHz}, \text{open drain}$ | - | 5 | - | Ω |

Dynamic characteristics

| | | | | | | |
|------------------------------|--------------|--|---|------|---|----|
| Input capacitance | C_{iss} | $V_{GS}=0\text{ V}, V_{DS}=25\text{ V}, f=1\text{ MHz}$ | - | 6090 | - | pF |
| Reverse transfer capacitance | C_{rSS} | | - | 1 | - | |
| Output capacitance | C_{oss} | $V_{GS}=0\text{ V}, V_{DS}=100\text{ V}, f=1\text{ MHz}$ | - | 260 | - | |
| Transconductance | g_{fs} | $V_{DS}>2 * I_D * R_{DS}, I_D=15\text{ A}$ | - | 40 | - | S |
| Turn-on delay time | $t_{d(on)}$ | $V_{DS}=380\text{ V}, V_{GS}=10\text{ V}, I_D=15\text{ A}, R_G=4\Omega \text{ (External)}$ | - | 49.5 | - | ns |
| Rise time | t_r | | - | 24.9 | - | |
| Turn-off delay time | $t_{d(off)}$ | | - | 267 | - | |
| Fall time | t_f | | - | 6.9 | - | |

| Parameter | Symbol | Conditions | Values | | | Unit |
|-----------|--------|------------|--------|-----|-----|------|
| | | | Min | Typ | Max | |

Gate charge characteristics

| | | | | | | |
|-----------------------|---------------|---|---|-----|---|----|
| Gate to source charge | Q_{gs} | $V_{DS}=480\text{ V}, I_D=30\text{ A},$ $V_{GS}=0\text{ to }10\text{ V}$ | - | 31 | - | nC |
| Gate to drain charge | Q_{gd} | | - | 65 | - | |
| Gate charge total | Q_g | | - | 189 | - | |
| Gate plateau voltage | $V_{plateau}$ | | - | 6.4 | - | V |

Reverse Diode

| | | | | | | |
|-------------------------------|----------|---|---|------|-----|---------------|
| Continuous forward current | I_S | $V_{GS}=0\text{ V}$ | - | - | 30 | A |
| Diode forward voltage | V_{SD} | $V_{GS}=0\text{ V}, I_S=I_F$ | - | 0.95 | 1.2 | V |
| Reverse recovery time | t_{rr} | $V_{RR}=50\text{ V}, I_S=I_F,$ $d_{iF}/d_t=100\text{ A}/\mu\text{S}$ | - | 552 | - | ns |
| Reverse recovery charge | Q_{rr} | | - | 12 | - | μC |
| Peak reverse recovery current | I_{rm} | | - | 35 | - | A |

Output Characteristics

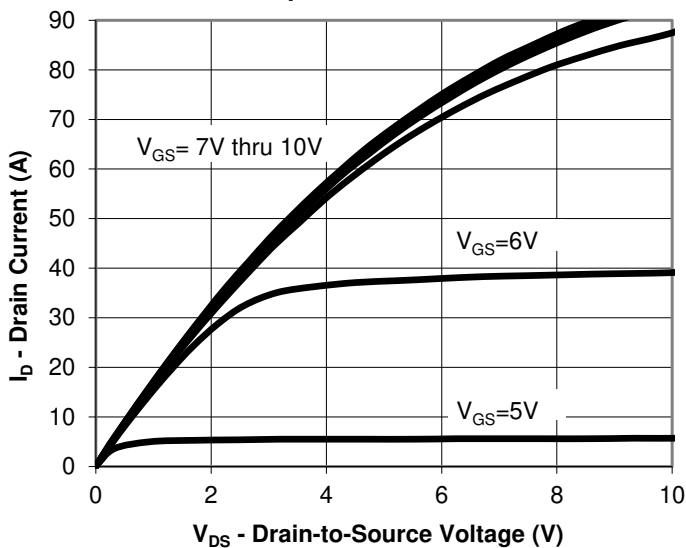

Transfer Characteristics

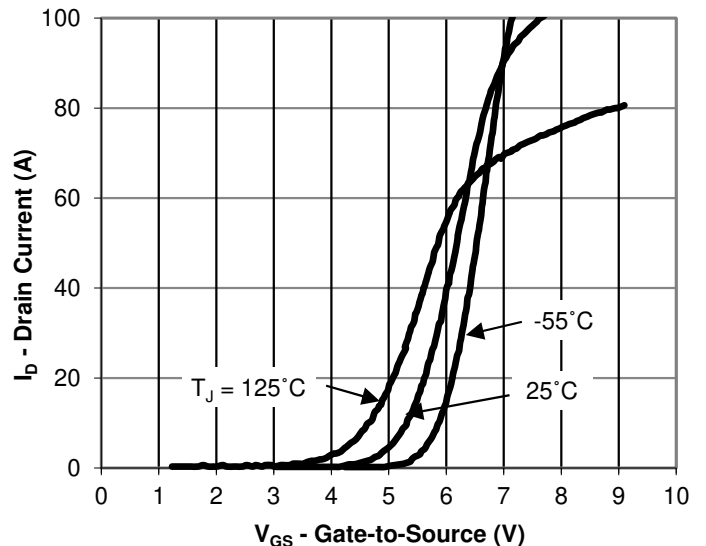

Drain-Source On-State Resistance vs. Drain Current

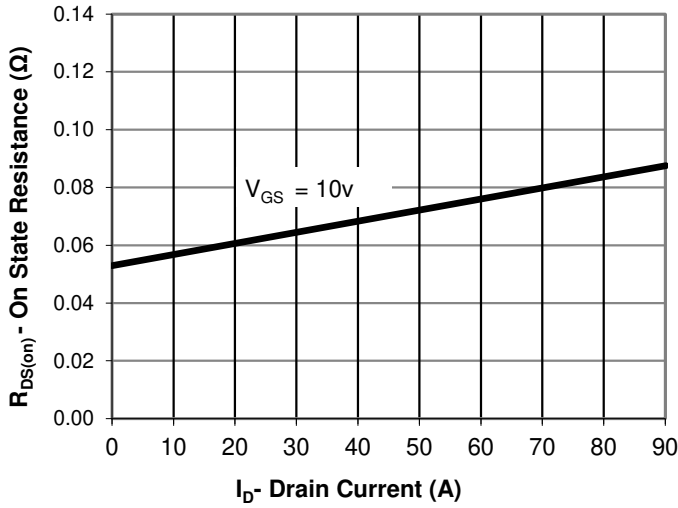

Drain-Source On-State Resistance vs. Gate-to-Source Voltage

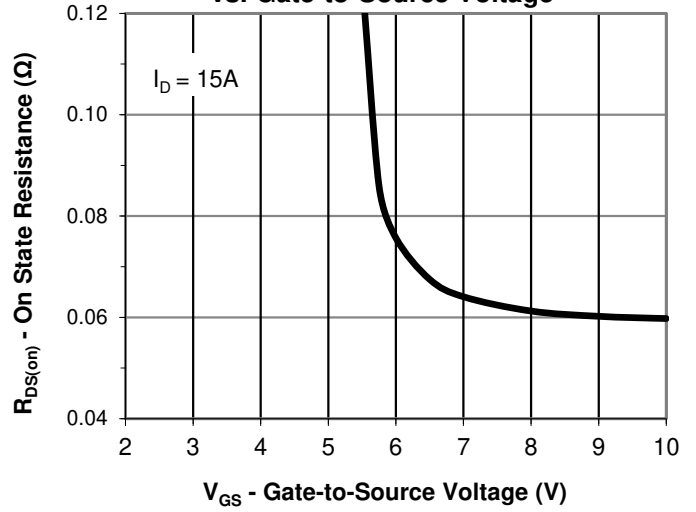

Drain-Source On State Resistance vs. Junction Temperature

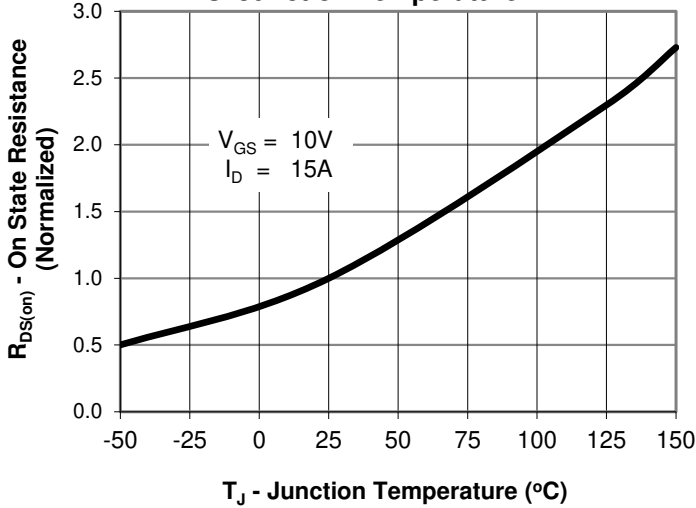

Gate Threshold Voltage vs. Junction Temperature

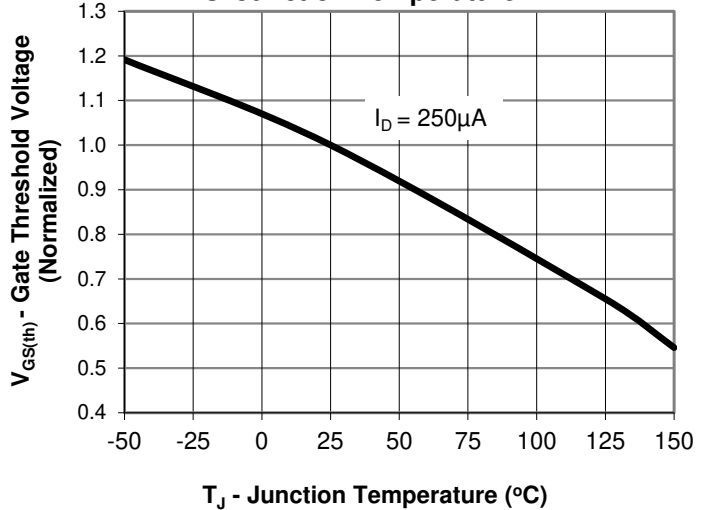

Gate Charge

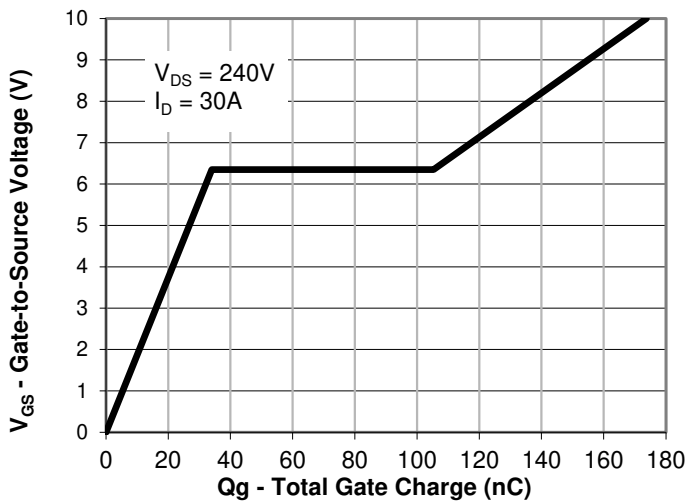

Drain-to-Source Breakdown Voltage vs. Junction Temperature

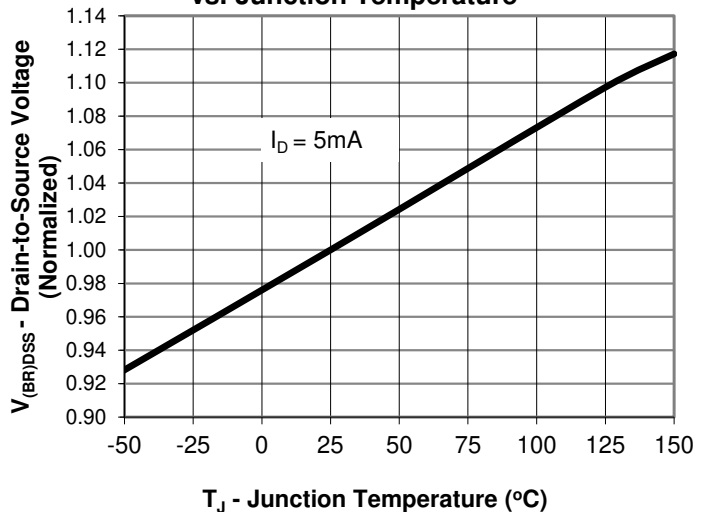

Capacitance

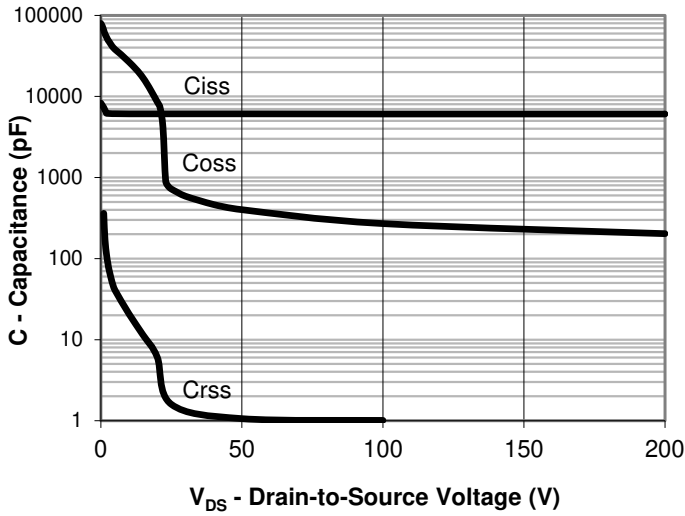

Source-Drain Diode Forward Voltage

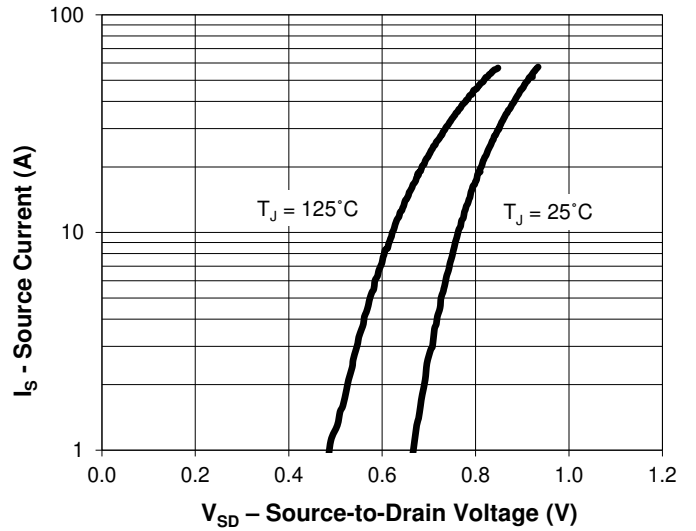

Maximum Rated Forward Biased Safe Operating Area

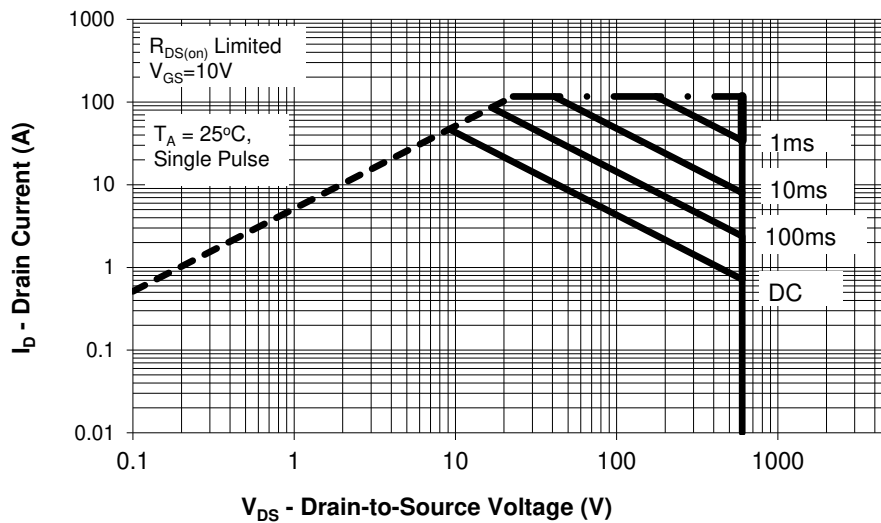

Transient Thermal Response, Junction-to-Ambient

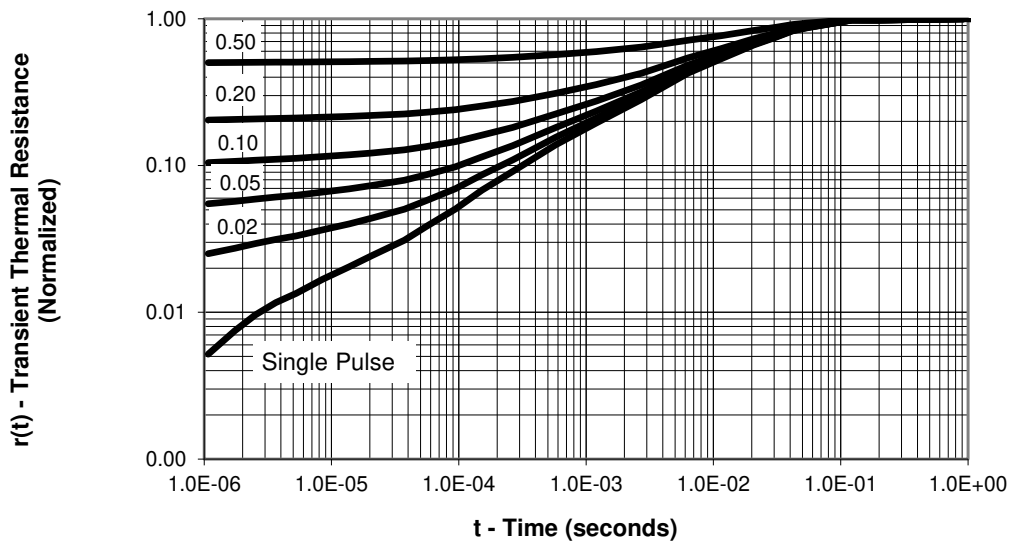

Package Outline: TO-247

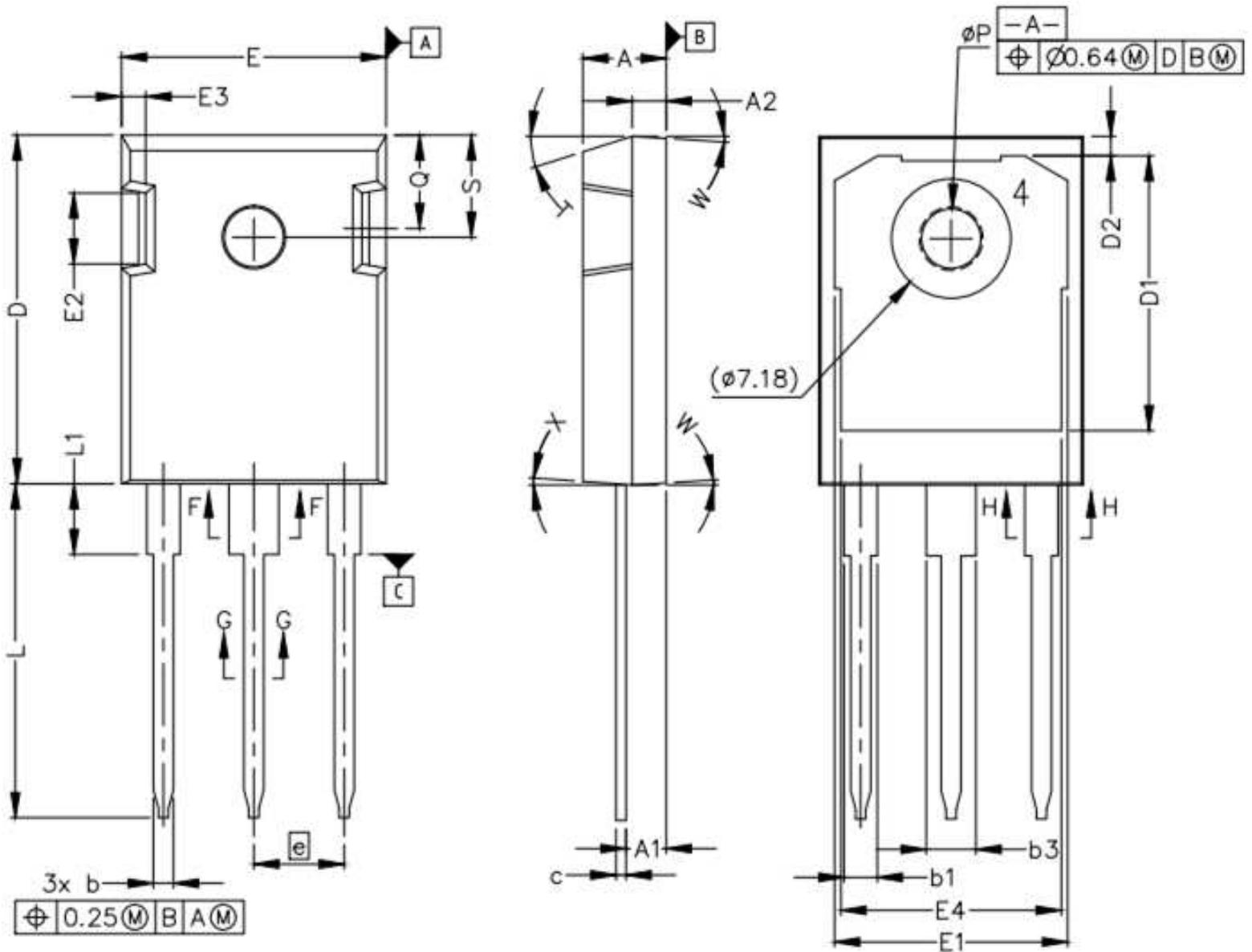

NOTE:
 1. ALL METAL SURFACES: TIN PLATED EXCEPT AREA OF CUT
 2. DIMENSIONING & TOLERANCING CONFIRM TO ASME Y14.5M-1994.
 3. ALL DIMENSIONS ARE IN MILLIMETERS. ANGLES ARE IN DEGREES.
 4. THIS DRAWING WILL MEET ALL DIMENSIONS REQUIREMENT OF JEDEC outlines TO-247 AD.

- 1 - GATE
- 2 - DRAIN (COLLECTOR)
- 3 - SOURCE (EMITTER)
- 4 - DRAIN (COLLECTOR)

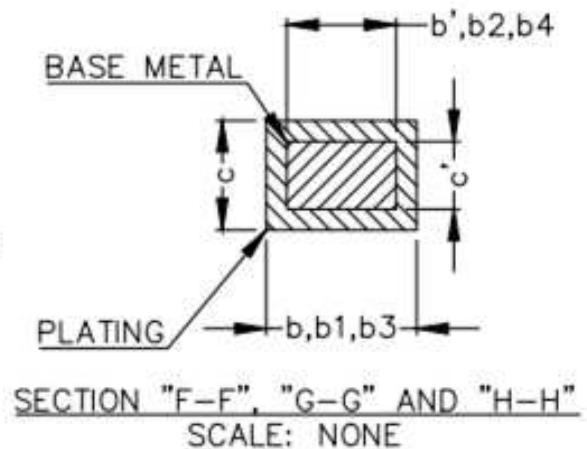

Package Outline: TO-247

| SYMBOL | MIN | MAX |
|--------|------------|-------|
| A | 4.83 | 5.21 |
| A1 | 2.29 | 2.54 |
| A2 | 1.91 | 2.16 |
| b' | 1.07 | 1.28 |
| b | 1.07 | 1.33 |
| b1 | 1.91 | 2.41 |
| b2 | 1.91 | 2.16 |
| b3 | 2.87 | 3.38 |
| b4 | 2.87 | 3.13 |
| c' | 0.55 | 0.65 |
| c | 0.55 | 0.68 |
| D | 20.80 | 21.10 |
| D1 | 16.25 | 17.65 |
| D2 | 0.95 | 1.25 |
| E | 15.75 | 16.13 |
| E1 | 13.10 | 14.15 |
| E2 | 3.68 | 5.10 |
| E3 | 1.00 | 1.90 |
| E4 | 12.38 | 13.43 |
| e | 5.44 BSC | |
| N | 3 | |
| L | 19.81 | 20.32 |
| L1 | 4.10 | 4.40 |
| φP | 3.51 | 3.65 |
| Q | 5.49 | 6.00 |
| S | 6.04 | 6.30 |
| T | 17.5° REF. | |
| W | 3.5° REF. | |
| X | 4° REF. | |

ICEMOS SUPERJUNCTION PATENT PORTFOLIO

ICEMOS GRANTED PATENTS

US7,429,772

US7,439,178

US7,446,018

US7,579,607

US7,723,172

US7,795,045

US7,846,821

US7,944,018

US8,012,806

US8,030,133

3D SEMI PATENTS LICENSED TO ICEMOS

US7,041,560B2

US7,023,069B2

US7,364,994

US7,227,197B2

US7,304,944B2

US7,052,982B2

US7,339,252

US7,410,891

US7,439,583

US7,227,197B2

US6,635,906

US6,936,867

US7,015,104

US9,109,110

US7,271,067

US7,354,818

US7,052,982,

US7,199,006B2

Note: additional patents in China, Korea, Japan, Taiwan, Europe have also been granted to IceMOS and 3D Semi for Superjunction MOSFETs with 70 additional Patent applications in process in the USA and the above listed countries.

Marking Information

YY = Last two digits of the year

WW = Work week

***** = Site ID

XXXXX = Lot ID

ICE30N60 = ICE is Icemos logo and 30N60 is a designated device part number

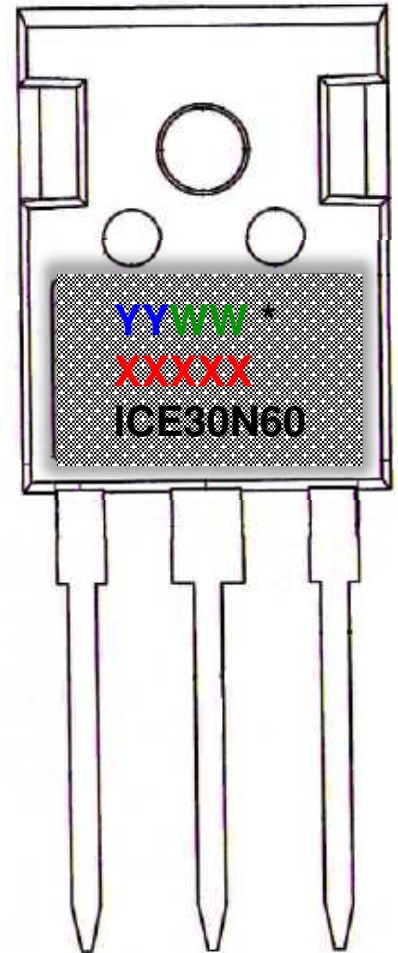

Disclaimer

Information contained in this data sheet shall in no event be regarded as a guarantee of conditions or characteristics. All product, data sheet are subject to change without notice to improve reliability. ICEMOS technology will not be responsible for damages of any nature resulting from the use or reliance upon the information contained in this data sheet.